

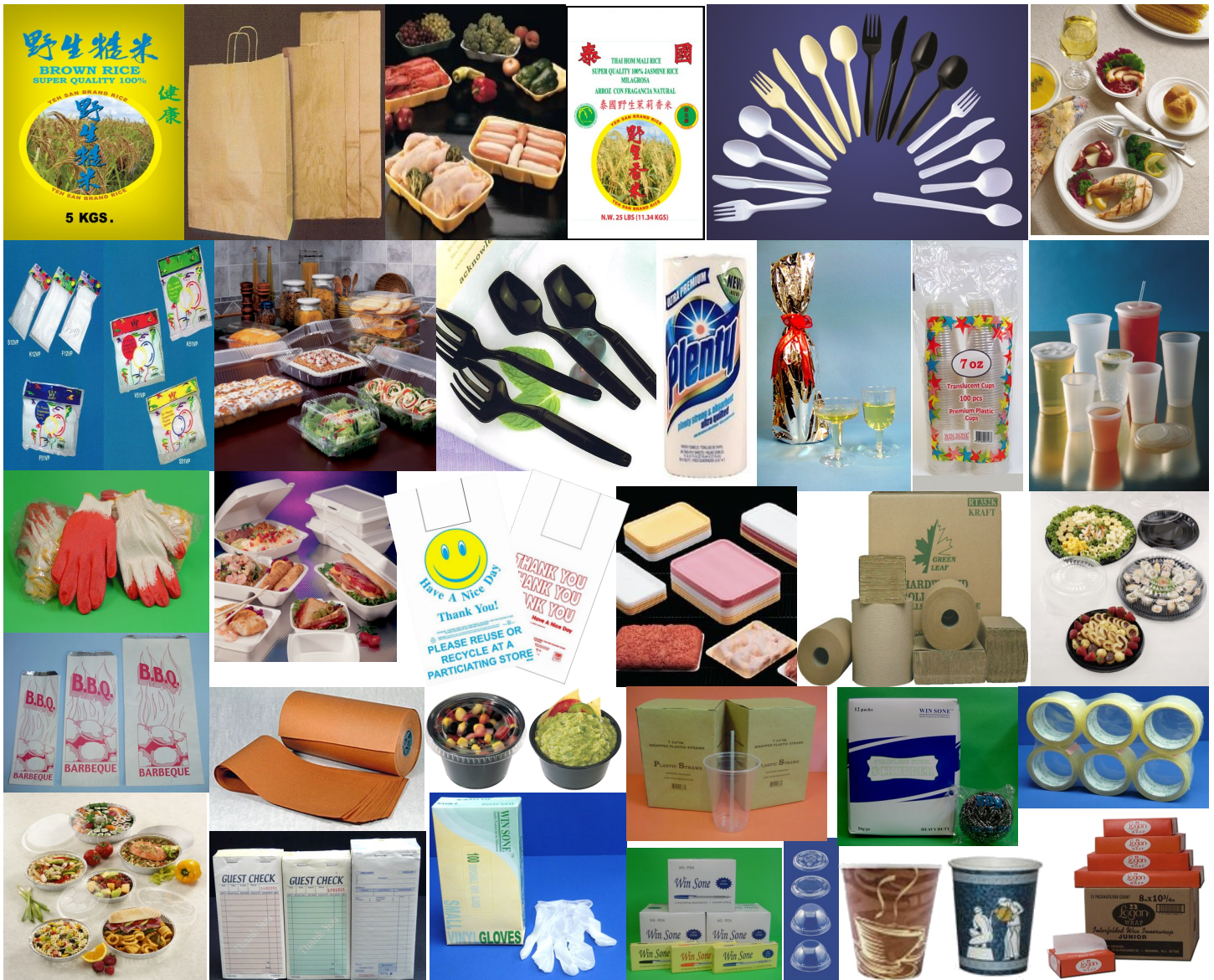

# SUPER WIN ENTERPRISES CORP.

## PAPER & PLASTICS DISTRIBUTOR

# Product Catalog



# Welcome to Super Win Enterprise Corp

We are a paper and plastics redistribution company servicing customers all across the United States.

Established since 1996 with an extensive knowledge of the industry; we supply our customers with the best range of products that include, but not limited to, disposable supplies, food packaging, and janitorial products.

We strive to provide our customers with unbeatable customer care, competitive pricing and consistent product quality.

We look forward to have the opportunity to serve you and thank you for your support.

Call us at: (718) 381-3381  
email us: [sales@superwinent.com](mailto:sales@superwinent.com)

# Table of Contents



DELTA PAPER



Aluminum Pans and Trays

Yeh San Brand Food

Plastic Food Containers

Plastic Cups and Lid

Disposable Plastic Tableware

Plastic Bags

PVC Film

Paper Products

Guest Checks, Register Rolls

Cleaning Supplies

Miscellaneous Products

Visit us online at: [www.superwinent.com](http://www.superwinent.com)

**WIN SONE**<sup>®</sup>  
Quality Products for the Millennium

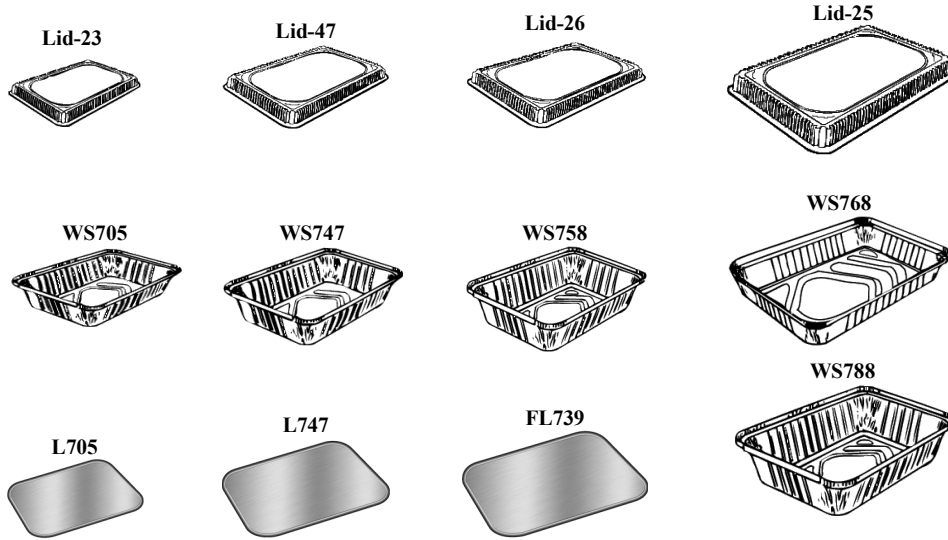

Win Sone	Lid#	Description	Packing
WS705-30/ WS705-35		1lb Oblong Aluminum Pan	1000
	Lid-23	Plastic Anti-Fog Lid	1000
	L705	Foil Laminated Board Lid	1000
WS747-30		1.5lb Oblong Aluminum Pan –Deep	500
	Lid-47	Plastic Anti-Fog Lid	500
	L747	Foil Laminated Board Lid	500
-		2lb Oblong Aluminum Pan	500
	Lid-26	Plastic Anti-Fog Lid	500
	FL739	Foil Laminated Board Lid	500
WS768-35		1.5lb Oblong Aluminum Pan - Shallow	500
	Lid-25	Plastic Anti-Fog Lid	500
		Foil Laminated Board Lid	500
WS788-40		2.25lb Oblong Aluminum Pan	500
	Lid-25	Plastic Anti-Fog Lid	500
		Foil Laminated Board Lid	500



**SUPER WIN ENTERPRISES CORP.**  
**PAPER & PLASTICS DISTRIBUTOR**

phone: (718) 381-3381 or email: [sales@superwinent.com](mailto:sales@superwinent.com)

**WIN SONE**<sup>®</sup>  
Quality Products for the Millennium

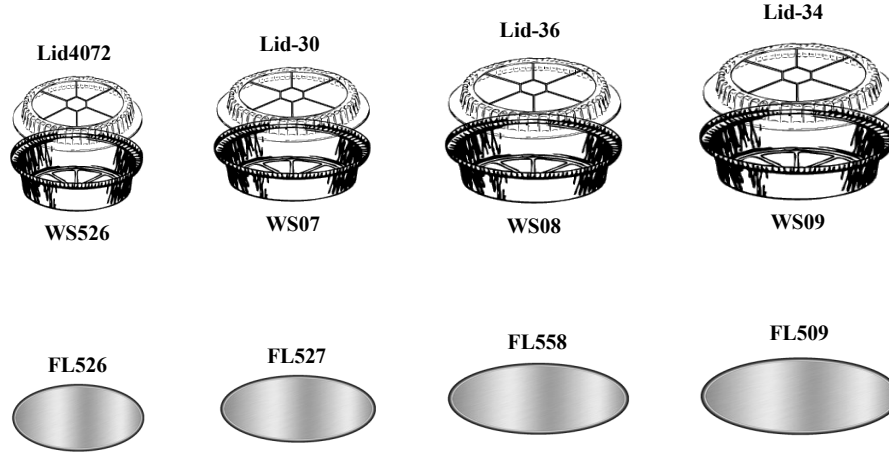

Win Sone	Lid#	Description	Packing
WS526-00		7" Slim Round Alum Pan	500
	LID4072	7" Slim Round Anti-Fog Lid	500
	FL526	7" Slim Foil Laminated Board Lid	500
WS07-00		7" Round Aluminum Container	500
WS07-30		7" Heavy Round Aluminum Container	500
	Lid-30	7" Round Anti-Fog Lid	500
	FL527	7" Foil Laminated Board Lid	500
WS08-00		8" Round Container	500
WS08-30		8" Heavy Round Container	500
	Lid-36	8" Round Anti-Fog Lid	500
	FL558	8" Foil Laminated Board Lid	500
WS09-00		9" Round Container	500
WS09-30		9" Heavy Round Container	500
	Lid-34	9" Anti-Fog Lid	500
	FL509	9" Foil Laminated Board Lid	500



**SUPER WIN ENTERPRISES CORP.**  
**PAPER & PLASTICS DISTRIBUTOR**

phone: (718) 381-3381 or email: [sales@superwinent.com](mailto:sales@superwinent.com)

**WIN SONE**  
Quality Products for the Millennium

Win Sone	Description	Packing
WS-6012-00	Half Size Steam Table - Shallow	100
WS-6112-40	Half Size Steam Table - Medium	100
WS-6132-00	Half Size Steam Table - Deep	100
WS-6132-40	Half Size Steam Table—Deep Heavy	100
WS-1012-00	LID for Half Size Steam Table	100
WS-6110-70	Full Size Steam Table - Shallow	40
WS-6120-00	Full Size Steam Table - Medium	40
WS-6050-00	Full Size Steam Table - Deep	40
WS-6050XHD	Full Size Steam Table - Deep Heavy	40
WS-1120-00	LID for Full Size Steam Table	40

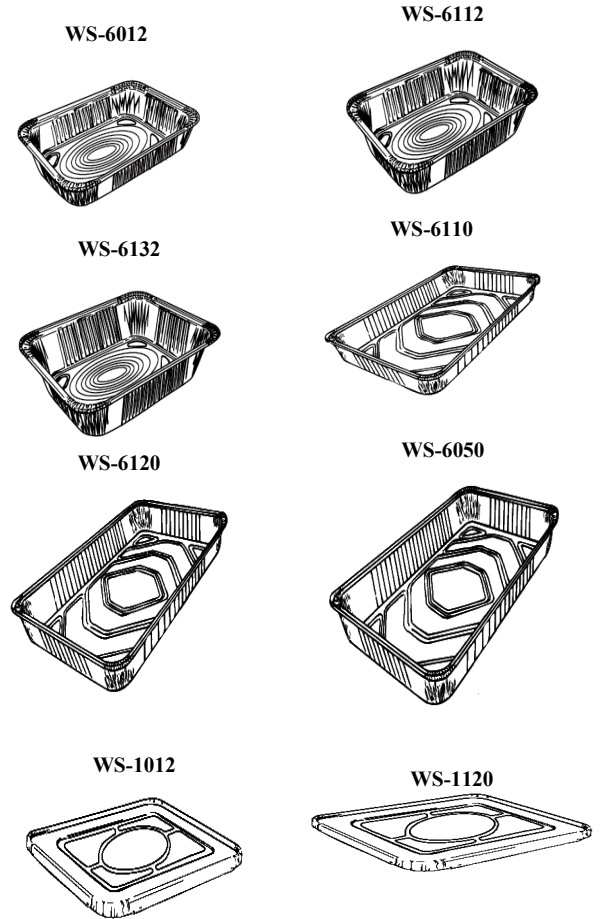

**WIN SONE**  
Quality Products for the Millennium

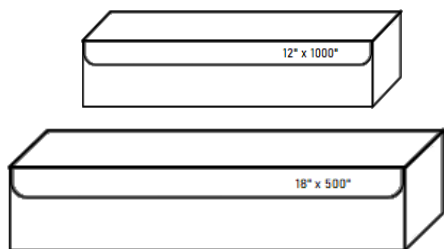

Win Sone	Description	Packing
12x1000StdFoil	12" x 1000' Foil Dispenser Roll - Standard	1
18x500 HvyFoil	18" x 500' Foil Dispenser Roll - Heavy	1



**SUPER WIN ENTERPRISES CORP.**  
**PAPER & PLASTICS DISTRIBUTOR**

phone: (718) 381-3381 or email: [sales@superwinent.com](mailto:sales@superwinent.com)

**WIN SONE**<sup>®</sup>  
 Quality Products for the Millennium

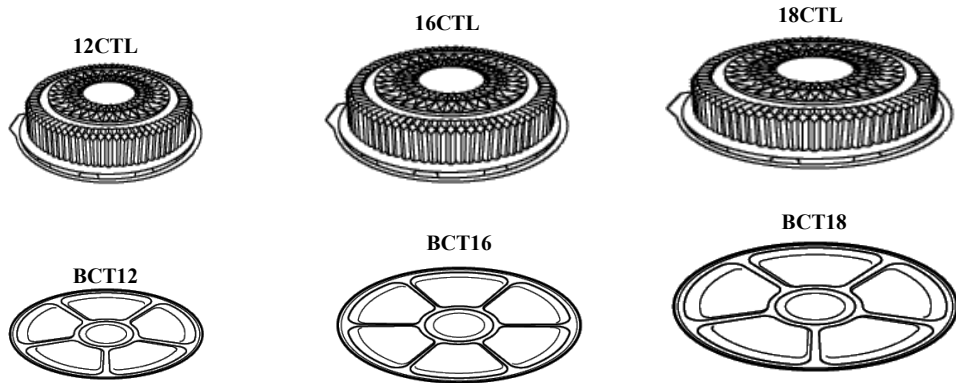

Stock#	Description	Packing
BCT12	12" Black Catering Tray	25
12CTL	High Dome Lid for 12in Blk Catering Tray	25
BCT16	16" Black Catering Tray	25
16CTL	High Dome Lid for 16in Blk Catering Tray	25
BCT18	18" Black Catering Tray	25
18CTL	High Dome Lid for 18in Blk Catering Tray	25



**SUPER WIN ENTERPRISES CORP.**  
**PAPER & PLASTICS DISTRIBUTOR**

phone: (718) 381-3381 or email: [sales@superwinent.com](mailto:sales@superwinent.com)

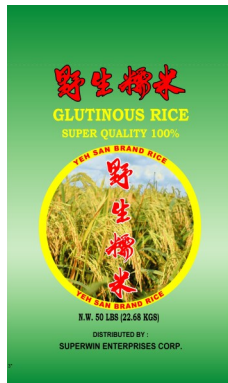
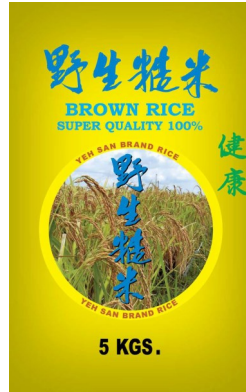

Stock#	Description
Brown Rice	5kg
Glutinous Rice	50lb.
Jasmine Rice	25lb.
Jasmine Rice	50lb.
Congee Rice	25lb.
Sushi Rice	50lb.



**SUPER WIN ENTERPRISES CORP.**  
**PAPER & PLASTICS DISTRIBUTOR**

phone: (718) 381-3381 or email: [sales@superwinent.com](mailto:sales@superwinent.com)



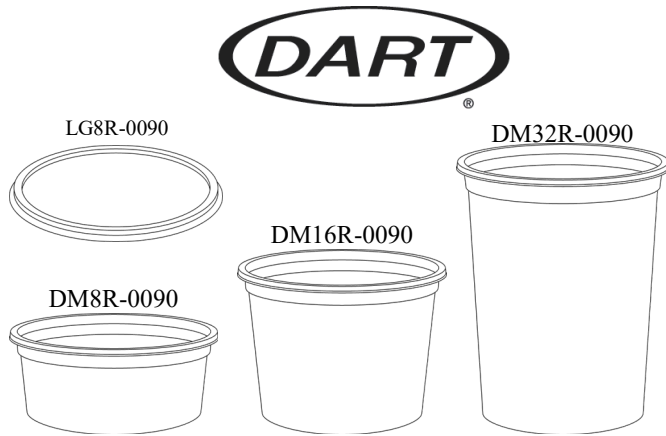

Stock#	Description	Packing
DM8R-0090	8oz Translucent Deli Container	500
DM16R-0090	16oz Translucent Deli Container	500
DM32R-0090	32oz Translucent Deli Container	500
LG8R-0090	Clear Lid for Deli Container	500



Stock#	Description	Packing
WS-DC8	8oz Deli Food Container	500
WS-DC16	16oz Deli Food Container	500
WS-DC32	32oz Deli Food Container	500
WS-DCL	Clear Natural Lid for 8oz to 32oz	500



Stock#	Description	Packing
HS8-COMBO	8oz Soup Container	240
HS16-COMBO	16oz Soup Container	240
HS32-COMBO	32oz Soup Container	240
HS-Lid	Soup Lid for 8oz to 32oz	480
HS8-Bottom	8oz Soup Container bottom	480
HS16-Bottom	16oz Soup Container bottom	480
HS32-Bottom	32oz Soup Container bottom	480



**WIN SONE**

Quality Products for the Millennium

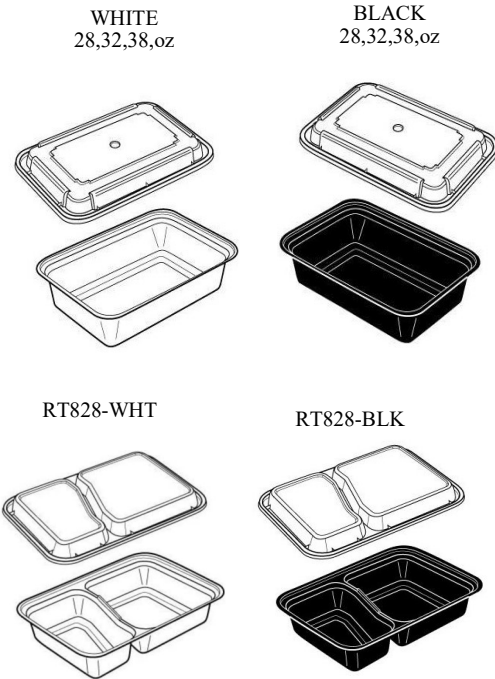

Stock#	Description	Packing
RT68-BLK	28oz Black Food Container with Lid	150
RT68-WHT	28oz White Food Container with Lid	150
RT78-BLK	32oz Black Food Container with Lid	150
RT78-WHT	32oz White Food Container with Lid	150
RT88-BLK	38oz Black Food Container with Lid	150
RT88-WHT	38oz White Food Container with Lid	150
RT828-BLK	30oz Black 2 Comp. Food Container with Lid	150
RT828-WHT	30oz White 2 Comp. Food Container with Lid	150
RT838-BLK	32oz Black 3 Comp. Food Container with Lid	150
RT838-WHT	32oz White 3 Comp. Food Container with Lid	150

**WIN SONE**

Quality Products for the Millennium

Stock#	Description	Packing
R618-WHT	18oz White Food Container with Lid	150
R618-BLK	18oz Black Food Container with Lid	150
R23-WHT	24oz White Food Container with Lid	150
R23-BLK	24oz Black Food Container with Lid	150
R29-WHT	32oz White Food Container with Lid	150
R29-BLK	32oz Black Food Container with Lid	150
R948-WHT	48oz White Food Container with Lid	150
R948-BLK	48oz Black Food Container with Lid	150

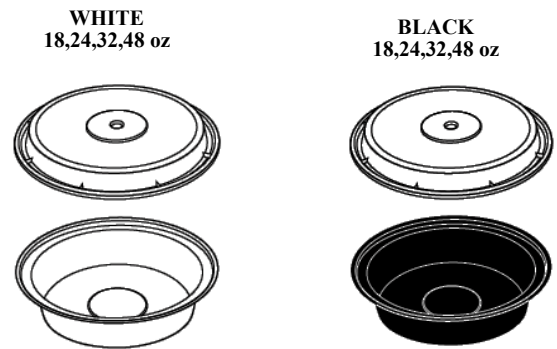

**SUPER WIN ENTERPRISES CORP.**  
**PAPER & PLASTICS DISTRIBUTOR**

phone: (718) 381-3381 or email: [sales@superwinent.com](mailto:sales@superwinent.com)

**WIN SONE**  
Quality Products for the Millennium

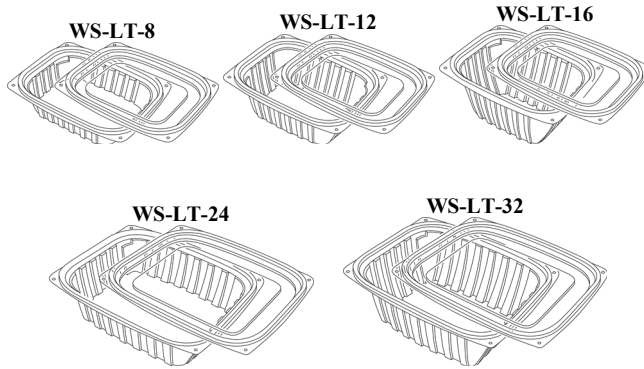

Stock#	Description	Packing
WS-LT-8	Anti-Fog 8oz. Clr. Rect. Cont. with Lid	250
WS-LT-12	Anti-Fog 12oz. Clr. Rect. Cont. with Lid	250
WS-LT-16	Anti-Fog 16oz. Clr. Rect. Cont. with Lid	250
WS-LT-24	Anti-Fog 24oz. Clr. Rect. Cont. with Lid	250
WS-LT-32	Anti-Fog 32oz. Clr. Rect. Cont. with Lid	250

Stock#	Description	Packing
C53PST1	5" Clear Hinge Smart Lock Container	500
C57PST1	6" Clear Hinge Smart Lock Container	500
C90PST1	9" 1-Compartment Medium Clear Hinge Container	250
C90PST3	9" 3-Compartment Medium Clear Hinge Container	250
C89PST1	9" Clear Hinge Sure Lock Container	250
C95PST1	9 1/2" Large Clear Hinge Container	200
C95PST3	9 1/2" Large 3-Compartment Clear Hinge Container	200

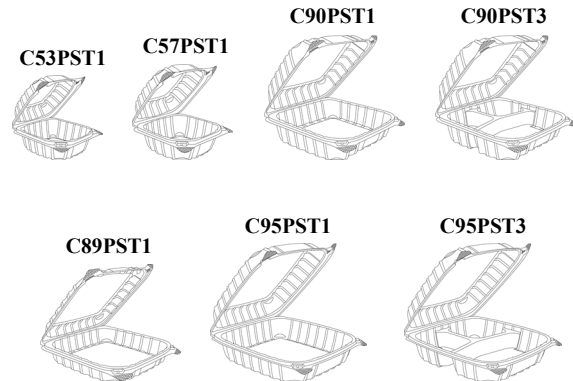



Stock#	Description	Packing
C4DER	4oz Clear Container	1000
C6DER	6oz Clear Container	1000
C8DER	8oz Clear Container	1000
C12DER	12oz Clear Container	1000
C16DERW	16oz Clear Container	1008
C24DER	24oz Clear Container	500
C32DER	32oz Clear Container	500
C48DER	48oz Clear Container	250
C64DER	64oz Clear Container	250
C30DE2R	2-Compartment Clear Container	250
C30DE3R	3-Compartment Clear Container	250

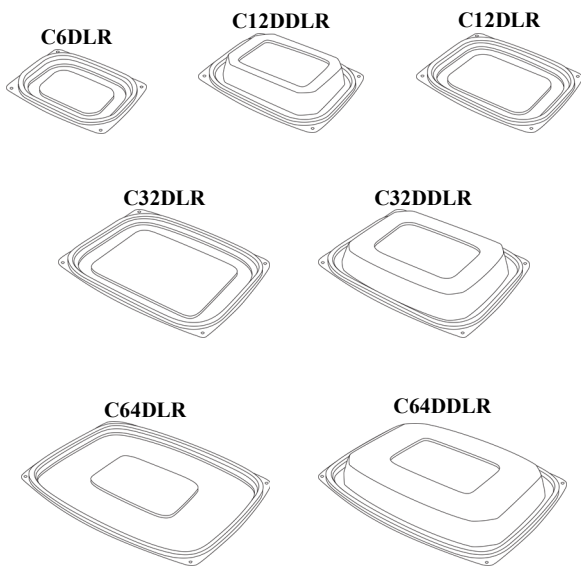
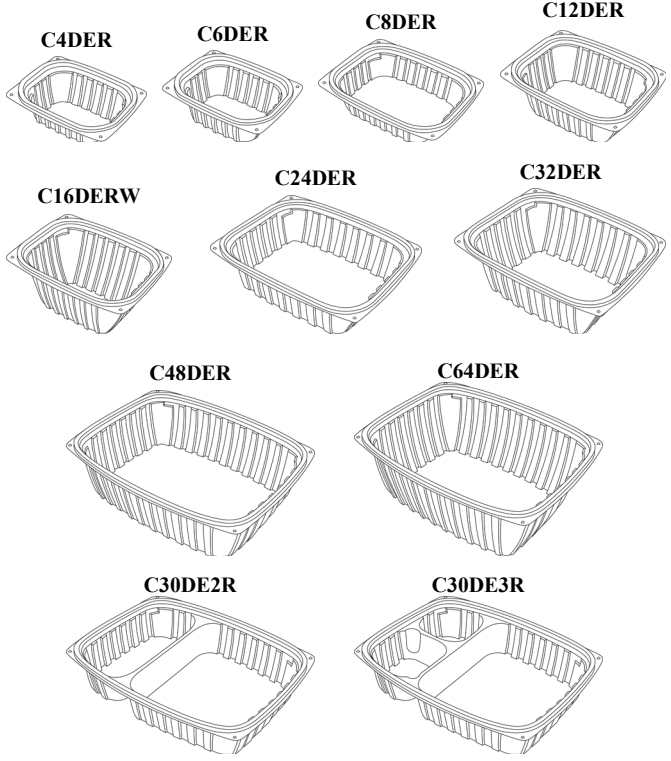

Stock#	Description	Packing
C6DLR	Flat Lid for C4DE, C6DE	1000
C12DDL	Dome Lid for C8DE, C12DE, C16DE	1000
C12DLR	Flat Lid for C8DE to C16DE	1000
C32DLR	Flat Lid for C24DE, C32DE	500
C32DDL	Dome Lid for C24DE, C32DE	500
C64DLR	Flat Lid for C48DE, C64DE, C30DE2	250
C64DDL	Dome Lid for C48DE, C64DE	250



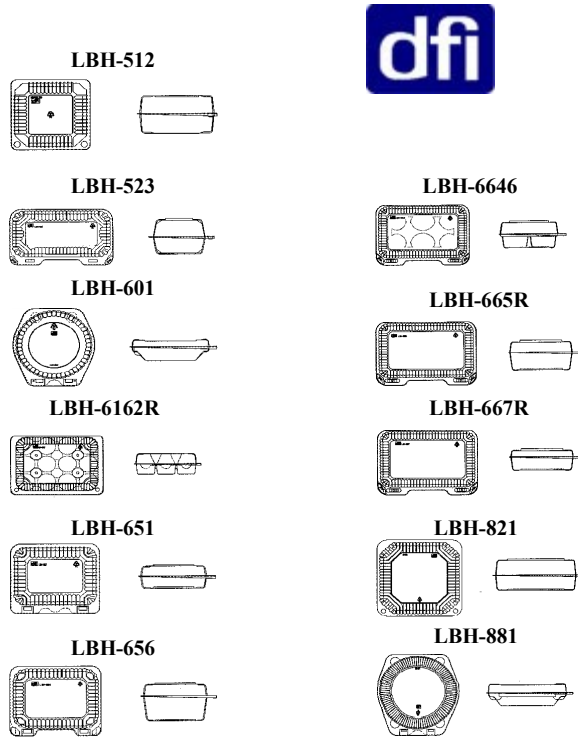

Stock#	Description	Packing
LBH-512	(20) Medium Button Lock Hinge Container	500
LBH-523	(35) Bar Lock Hinge Container	500
LBH-601	(106) 6" Shallow Bar Lock Hinge Pie Container	250
LBH-6162R	(34) 12 Muffin Button Lock Hinge Container	350
LBH-651	(26) Shallow Bar Lock Hinge Container	500
LBH-656	(27) Deep Bar Lock Hinge Container	500
LBH-6646	(46) 6 Muffin Bar Lock Hinge Container	350
LBH-665R	(40) Bar Lock Hinge Container	350
LBH-667R	(30) Medium Bar Lock Hinge Container	350
LBH-821	(70) Deep Button Lock Hinge Container	250
LBH-881	(108) 8" Shallow Bar Lock Hinge Pie Container	100



Stock#	Description	Packing
C8BCD	8oz Clear Bowl with Dome Lid	252
C12BCD	12oz Clear Bowl with Dome Lid	252
C16BCD	16oz Clear Bowl with Dome Lid	252
C24BCD	24oz Clear Bowl with Dome Lid	126
C32BCD	32oz Clear Bowl with Dome Lid	126
C48BCD	48oz Clear Bowl with Dome Lid	126
C64BCD	64oz Clear Bowl with Dome Lid	126

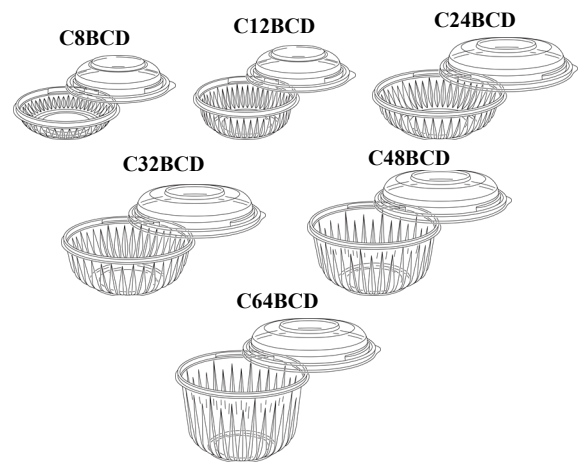

Stock#	Description	Packing
WS-18RB	18oz Rose Bowl with Lid	150
WS-24RB	24oz Rose Bowl with Lid	150
WS-32RB	32oz Rose Bowl with Lid	150
WS-40RB	40oz Rose Bowl with Lid	150
WS-48RB	48oz Rose Bowl with Lid	150
WS-64RB	64oz Rose Bowl with Lid	100

**WIN SONE**  
Quality Products for the Millennium

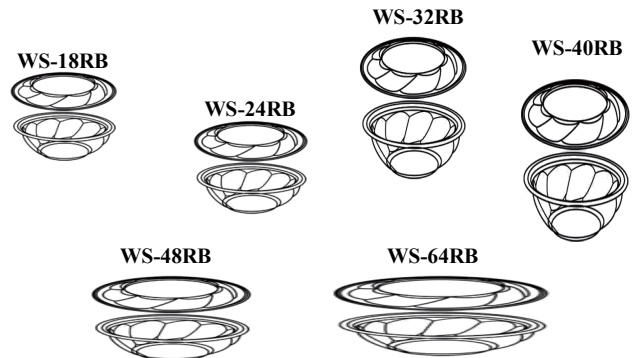

Stock#	Description	Packing
PT -1 1/2-CLR	#1 1/2 clear tray 8.3x4x1	2 x 250 pcs
PT -1 1/2-BLK	#1 1/2 black tray 8.3x4x1	
PT-2-CLR	#2 clear tray 8.1x5.11x1.4	2x 125 pcs
PT-2-BLK	#2 black tray 8.1x5.11x1.4	
PT-4P-CLR	#4P clear tray 9.3x7.11x1.2	2x 125 pcs
PT-4P-BLK	#4P black tray 9.3x7.11x1.2	
PT-5S-CLR	#5S clear tray 10.4x5.4x0.6	2x 125 pcs
PT-5S-BLK	#5S black tray 10.4x5.4x0.6	
PT-8P-CLR	#8P clear tray 10x7.8x1.4	2x 100 pcs
PT-8P-BLK	#8P black tray 10x7.8x1.4	
PT-17S-CLR	#17S clear tray 8.4x4.6x0.7	2x 100 pcs
PT-17S-BLK	#17S black tray 8.4x4.6x0.7	
PT-42P-CLR	#42P clear tray 8.1x5.1x2	2x 100 pcs
PT-42P-BLK	#42P black tray 8.1x5.1x2	

**WIN SONE**  
Quality Products for the Millennium



**SUPER WIN ENTERPRISES CORP.**  
**PAPER & PLASTICS DISTRIBUTOR**

phone: (718) 381-3381 or email: sales@superwinent.com



**Translucent  
Portion Cups**

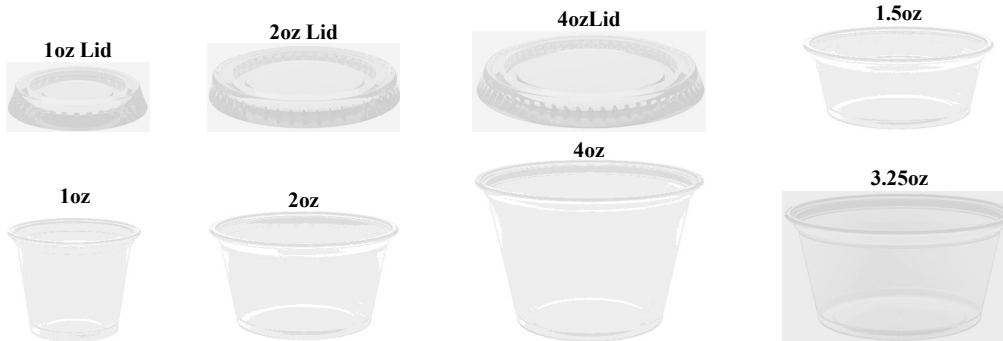

Stock#	Description	Packing
PL100N	1oz Solo Portion Cup Clear Lid	2500
PL200N	1.5, 2.0, 2.5oz Solo Portion Cup Clear Lid	2500
PL4N	3.25, 4, 5.5oz Solo Portion Cup Clear Lid	2500
P100N	1 oz Solo® Soufflés Plastic Portion Cups	2500
P150N	1.5 oz Solo® Soufflés Plastic Portion Cups	2500
P200N	2 oz Solo® Soufflés Plastic Portion Cups	2500
P325N	3.25oz Solo® Soufflés Plastic Portion Cups	2500
P400N	4 oz Solo® Soufflés Plastic Portion Cups	2500
P550N	5.5oz Solo® Soufflés Plastic Portion Cups	2500
	* Portion Cups available in Black and Clear	

®

**WIN SONE**

Quality Products for the Millennium

**Heavy Duty  
Portion Cups**

Stock#	Description	Packing
1HPCUP	1oz Clear Heavy Portion Cups PP	2500
1HPLID	1oz Clear Heavy Portion Lids PP	2500
150HPCUP	1.5oz Clear Heavy Portion Cups PP	2500
2HPCUP	2oz Clear Heavy Portion Cups PP	2500
2HPLID	1.5oz/2oz Clear Heavy Portion Lids PP	2500



**SUPER WIN ENTERPRISES CORP.**  
**PAPER & PLASTICS DISTRIBUTOR**

phone:(718) 381-3381 or email: sales@superwinent.com

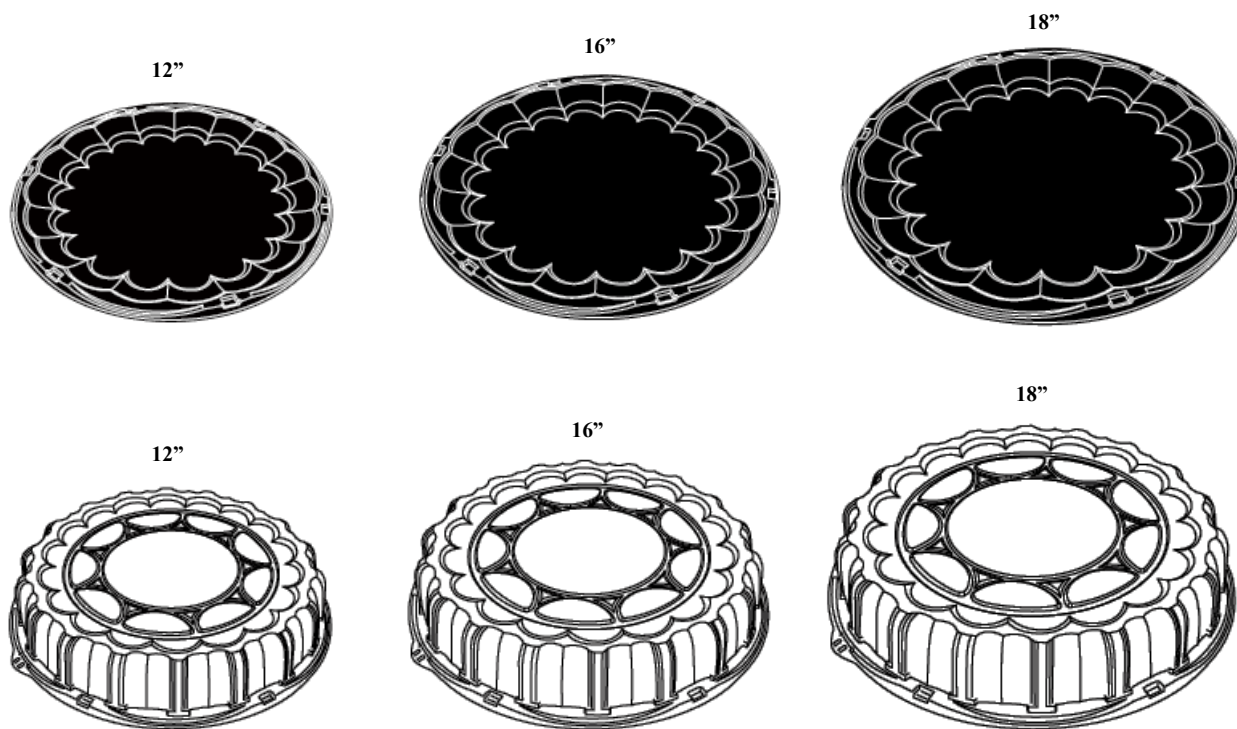

Win Sone	Description
BCT12	12" Black Smart Lock Catering Tray
BCT16	16" Black Smart Lock Catering Tray
BCT18	18" Black Smart Lock Catering Tray
12CTL	12" Dome Lid
16CTL	16" Dome Lid
18CTL	18" Dome Lid





**Super Win Enterprises Corp.**  
Tel: (718) 381-3381

**WIN SONE**<sup>®</sup>  
Quality Products for the Millennium

Stock#	Description	Packing
WS-12CC	12oz Clear Cup	1000
WS-14CC	12oz SQT Clear Cup	1000
WS-16CC	16oz Clear Cup	1000
WS-20CC	20oz Clear Cup	600
WS-24CC	24oz Clear Cup	600
WS-32CC	32oz Clear Cup	500

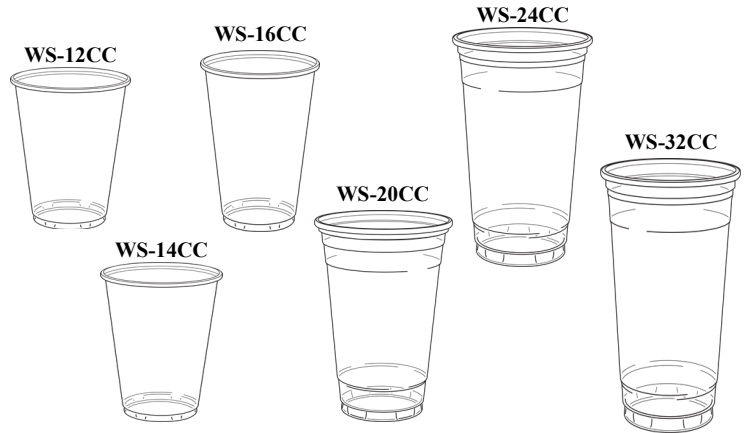

Stock#	Description	Packing
Y35	3.5 oz Cold Cup -Translucent	2500
Y5	5 oz Cold Cup -Translucent	2500
Y7	7 oz Cold Cup -Translucent	2500
Y9	9 oz Cold Cup -Translucent	2500
Y10	10 oz Cold Cup -Translucent	2500
Y12S	12 oz Cold Cup -Translucent	2500
Y14	14 oz Cold Cup -Translucent	2500
P16	16 oz Cold Cup -Translucent	1000

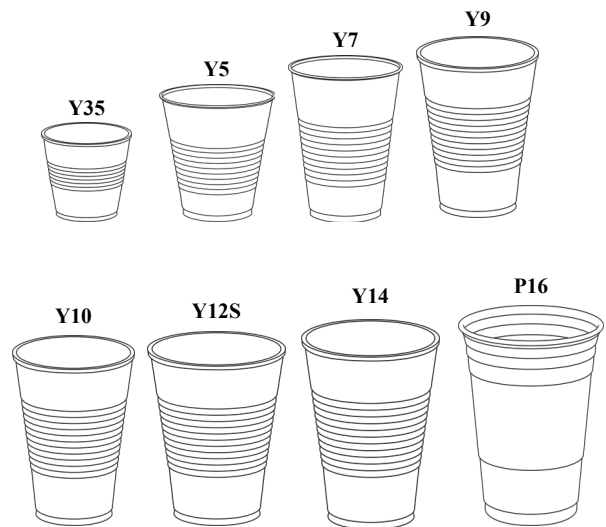

Stock#	Description	Packing
Y7100-0100	7oz Translucent Cup Retail	12/100
Y980-0100	9oz Translucent Cup Retail	12/80
7TC	7oz PET clear cup retail	12/100

Y7100-0100



Y980-0100



7TC



**SUPER WIN ENTERPRISES CORP.**  
**PAPER & PLASTICS DISTRIBUTOR**

phone: (718) 381-3381 or email: [sales@superwinent.com](mailto:sales@superwinent.com)

**Super Win Enterprises Corp.**  
Tel: (718) 381-3381

**WIN SONE**®  
Quality Products for the Millennium



Stock#	Description	Packing
9-CUP	9oz Clear Round Cup	10pcs
10TB	10oz Clear Square Tumbler	20pcs
WG1	1-piece 5oz Wine Glass	5pcs
WG2	2-piece Clear Wine Glass	6pcs
CCG	2-piece Clear Champagne Glass	6pcs

Stock#	Description	Packing
DL620	Clear Dome with NO Hole for 16 to 24oz Cup	1000
DL668	Clear Dome with 1" Hole for 16 to 24oz Cup	1000
626TS	Clear Straw Slotted Lid for TP12S, TP16D, TP20, TD24, TD26	1000
626TP	Clear Non-Vented Clear Lid for TP12S, TP16D, TP20, TD24, TD26	1000
610TS	Straw-Slotted Clear Lid For 9 Oz, 10 Oz TALL Clr Cup 1M	1000
695TS	Straw-Slotted Lid For SQUAT 12SN,14N,14K (1M)	1000
DLW626	2" Hole Clr Dome Lid For 16-24 Oz SQUAT Clr Cup	1000
DLW662	2" Hole Clr Dome Lid For 16 -24 Oz TALL Clr Cup	1000



**DL620**

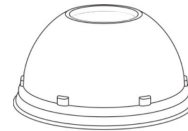

**DL668**

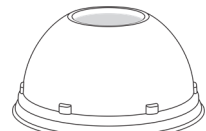

**626TS**

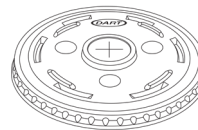

**626TP**

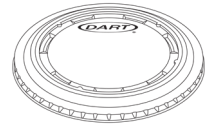

**DLW662**



**DLW626**



**SUPER WIN ENTERPRISES CORP.**  
**PAPER & PLASTICS DISTRIBUTOR**

phone: (718) 381-3381 or email: [sales@superwinent.com](mailto:sales@superwinent.com)

**Super Win Enterprises Corp.**  
Tel: (718) 381-3381

**WIN SONE**<sup>®</sup>  
Quality Products for the Millennium

**1 inch DOME Lid**  
(WS-12DL / WS-1624DL)



**Flat Lid**  
(WS-12SL / WS-1624SL / WS-32SL)

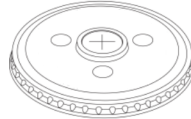

**Strawless Lid**  
(WS-1624NS)



**2 inch Dome LID**  
(WS-2inDL)



Stock#	Description	Packing
WS-12DL	PET Dome Lid 1" hole for 12oz Cold Cup	1000
WS-12SL	PET Flat Lid for 12oz Cold Cup	1000
WS-1624DL	Clear Dome Lid with 1" hole fits 16-24oz	10x100
WS-2inDL	Clear Dome Lid with 2" hole fits 16-24oz	10x100
WS-1624NS	No Straw Cold Cup PET Lid fits 16-24oz	10x100
WS-1624SL	Clear Straw Slot Lid fits 16-24oz	10x100
WS-32SL	Clear Straw Slot Lid High Clarity & Leak-Resistant for 32oz	10x50



**SUPER WIN ENTERPRISES CORP.**  
**PAPER & PLASTICS DISTRIBUTOR**

phone: (718) 381-3381 or email: [sales@superwinent.com](mailto:sales@superwinent.com)

**Super Win Enterprises Corp.**  
Tel: (718) 381-3381

**Custom Print Available**

*See Our New  
Slim, Line Cutlery*

**WIN SONE**  
Quality Products for the Millennium

Stock#	Description	Packing
WS-SPWF	Med. Fork	1000
WS-SPWK	Med. Knife	1000
WS-SPWSS	Med. Soup Spoon	1000
WS-SPWTS	Med. Teaspoon	1000
WSK	Med. White Spork	1000
SP-Sodaspoon	Med. Soda Spoon	1000
PSF	Med. Clear/White Fork	1000
PSK	Med. Clear/White Knife	1000
PSS	Heavy Black/Honey/White Soup Spoon	1000
PST	Med. Teaspoon	1000
P2F	Heavy Black/Honey/White Fork	1000
P2K	Heavy Black/Honey/White Knife	1000
P2SS	Heavy Black/Honey/White Soup Spoon	1000
P2TS	Heavy Black/Honey/White Teaspoon	1000
P4F	Heavy PS Black/Clear/White Fork	1000
P4K	Heavy PS Black/Clear/White Knife	1000
P4S	Heavy PS Black/Clear/White Teaspoon	1000
P4Taste	Heavy PS White Taster Spoon	3000

**White Soup Spoon, Teaspoon, Fork, and Knife**



**White Spork**



**Soda Spoon**



**Honey Soup Spoon, Teaspoon, Fork, and Knife**



**Black Soup Spoon, Teaspoon, Fork, and Knife**



**Taster Spoon**



Stock #	Description	Packing
Fork	6" White Fork	1000
Knife	6" White Knife	1000
Soup Spoon	6" Soup Spoon	1000
Teaspoon	6" Teaspoon	1000
Soda Spoon	8" White Soda Spoon	1000

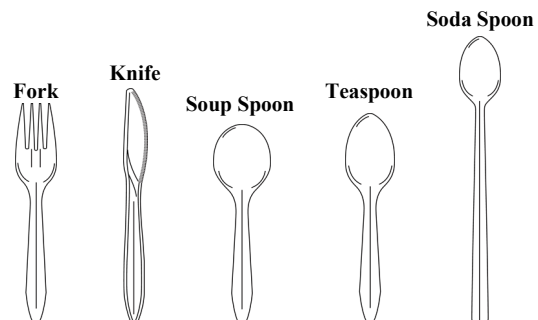

**SUPER WIN ENTERPRISES CORP.**  
**PAPER & PLASTICS DISTRIBUTOR**

phone: (718) 381-3381 or email: sales@superwinent.com

**Super Win Enterprises Corp.**  
Tel: (718) 381-3381

**Custom Print Available**

**WIN SONE**  
Quality Products for the Millennium

**Individually Packed Fork, Knife, Soup Spoon, Teaspoon, and Soda Spoon**



Stock#	Description	Packing
IPWF	Individually Packed White Fork	1000
IPWK	Individually Packed White Knife	1000
IPWS	Individually Packed White Soup Spoon	1000
IPWT	Individually Packed White Teaspoon	1000
IP-WPP-Soda	Individually Packed White Soda Spoon	1000

Stock#	Description	Packing
F12VP	Medium White Fork	12pcs/48pks/9cs
K12VP	Medium White Knife	12pcs/48pks/9cs
S12VP	Medium White Teaspoon	12pcs/48pks/9cs
F51VP	Medium White Fork	51pcs/48pks
K51VP	Medium White Knife	51pcs/48pks
S51VP	Medium White Teaspoon	51pcs/48pks
V51VP	Medium White Fork/Knife/Teaspoon	51pcs/48pks



**Serving Fork and Spoon**



Stock #	Description	Packing
SF9C	9" Clear Salad Serving Fork	144
SF9B	9" Black Salad Serving Fork	144
SS9C	9" Clear Salad Serving Spoon	144
SS9B	9" Black Salad Serving Spoon	144

Stock#	Description	Packing
TG9C	9" Clear Tong	48
TG9B	9" Black Tong	48
TG12C	12" Clear Tong	48

**Tong**



**SUPER WIN ENTERPRISES CORP.**  
**PAPER & PLASTICS DISTRIBUTOR**

phone: (718) 381-3381 or email: [sales@superwinent.com](mailto:sales@superwinent.com)

**Super Win Enterprises Corp.**  
Tel: (718) 381-3381

## WIN SONE®

Quality Products for the Millennium

Stock#	Description	Packing
MK82	Heavy White Fork, Knife, Napkin, Salt and Pepper	250
MK86	Heavy Fork, Knife, Teaspoon and Napkin	250
MK95	Med. Fork, Knife, Napkin, Salt and Pepper	250
MK96	Med. Fork, Knife, Teaspoon, Napkin, Salt and Pepper	250
MK97	Med. Fork, Knife, Soup Spoon, Napkin, Salt and Pepper	250 or 500
MK231	Med. White Fork, Knife and Napkin	250 or 500
MK241	Med. White Fork, Knife, Soup Spoon and Napkin	250 or 500
MK242	Med. Fork, Knife, Teaspoon and Napkin	250
MK251	Med. Fork, Knife, Teaspoon, Soupspoon and Napkin	250
MK274	Heavy PS Clear Fork, Knife, Napkin, Salt and Pepper	250 or 500
MK674	Heavy PS Clear Fork, Knife, Soupspoon, Napkin, Salt and Pepper	250
Spork Kit	Med. Spork, Straw and Napkin	1000

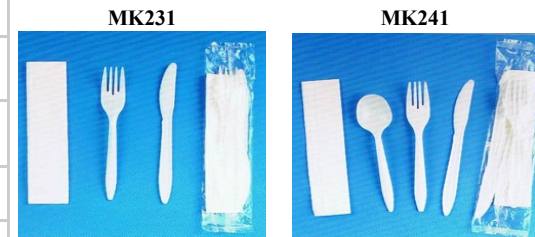

### Individually Wrapped Straw



Flexible Straw



Jumbo Mixed Straw



### Pizza Saver Stand



Plastic Wrapped Straw



Stirrer



### Biodegradable Plastic

Stock #	Description	Packing
OB-IP-Straw	7 3/4" Plastic Ind. Wrapped Straws	24 boxes
OB-IPMIX Straw	8" Jumbo Straw, Mixed Colors	600
OB-5" Stirrer	5" Coffee Stirrer	10/1000
OB-8" Stirrer	8" Coffee Stirrer	10/1000
PZ1000	Pizza Saver Stand	1000



**SUPER WIN ENTERPRISES CORP.**  
**PAPER & PLASTICS DISTRIBUTOR**

phone: (718) 381-3381 or email: sales@superwinent.com

**Super Win Enterprises Corp.**  
Tel: (718) 381-3381

**WIN SONE**  
Quality Products for the Millennium



Stock#	Description	Packing
5BWWF	5oz Plastic Bowl	1000
12BWWF	12oz Plastic Bowl	1000

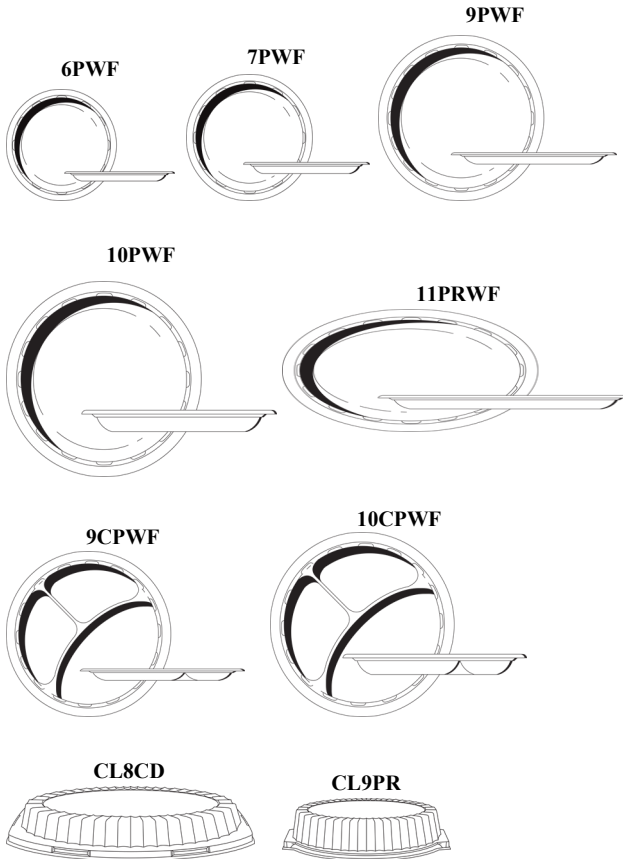
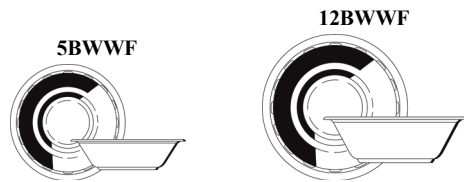

Stock#	Description	Packing
6PWF	6" Plastic Plate	1000
7PWF	7" Plastic Plate	1000
9CPWF	9" 3-Compartment Plastic Plate	500
9PWF	9" Plastic Plate	500
10CPWF	10" 3-Compartment Plastic Plate	500
10PWF	10" Plastic Plate	500
11PRWF	11" Oval Plastic Plate	500
CL8CD	Clear Lid for 8CDHQ	1000
CL9PR	Clear Dome Lid for 9PRWC, 9PRWQ	1000



**SUPER WIN ENTERPRISES CORP.**  
**PAPER & PLASTICS DISTRIBUTOR**

phone: (718) 381-3381 or email: [sales@superwinent.com](mailto:sales@superwinent.com)



Stock#	Description	Packing
ZB4X4	4" x 4" Clear Deli Zip Bag	1000
ZB4X6	4" x 6" Clear Deli Zip Bag	1000
ZB5X7	5" x 7" Clear Deli Zip Bag	1000
ZB10X8	10.25" x 8" Clear Deli Zip Bag	1000
Deli Bag	Deli Bag with no Zipper	2000

®

## WIN SONE

Quality Products for the Millennium

Stock#	Description
4x2x8R	Clear Poly Bag
4x2x8HD	Clear Poly Bag Heavy Duty
4x2x12R	Clear Poly Bag
4x2x12HD	Clear Poly Bag Heavy Duty
6x3x15R	Clear Poly Bag
6x3x15M	Clear Poly Bag Medium
6x3x15XHD	Clear Poly Bag Extra Heavy
6x3x15Vent	Clear Poly Bag Vented
8x4x14	Clear Poly Bag Vented
8x4x18R	Clear Poly Bag
8x4x18M	Clear Poly Bag Medium
8x4x18XHD	Clear Poly Bag Extra Heavy
8x4x18Vent	Clear Poly Bag Vented
10x8x24R	Clear Poly Bag
10x8x24M	Clear Poly Bag Medium
10x8x24XHD	Clear Poly Bag Extra Heavy
12x8x30H	Clear Poly Bag Heavy
5lb Ice Bag	5lb Capacity Ice Bag
10lb Ice Bag	10lb Capacity Ice Bag



**SUPER WIN ENTERPRISES CORP.**  
**PAPER & PLASTICS DISTRIBUTOR**

phone: (718) 381-3381 or email: [sales@superwinent.com](mailto:sales@superwinent.com)





**WIN SONE**<sup>®</sup>  
Quality Products for the Millennium



Stock #	Description
XHD39CLR	#9104 23 x 10 x 39 Extra Heavy Duty Clear Garbage Bag
XHD46CLR	# 2346 23 x 17 x 46 Extra Heavy Duty Clear Garbage Bag
XHD55CLR	#3455 34 x 55 Extra Heavy Duty Clear Garbage Bag
HD39	39 Gallon Heavy Duty Garbage Bag
XHD39	#910 39 Gallon Extra Heavy Duty Black Garbage Bag
XXHD39	#210 39 Gallon Extra Heavy Duty Black Garbage Bag
XXHD39K	#218 39 Gallon Extra Heavy Duty Black Garbage Bag
HD46	46 Gallon Heavy Duty Garbage Bag
XHD46	#920 46 Gallon Extra Heavy Duty Black Garbage Bag
XXHD46	#220 46 Gallon Extra Heavy Duty Black Garbage Bag
XXHD46BG	#225 46 Gallon Extra Heavy Duty Black Garbage Bag
XXHD46K	#228 46 Gallon Extra Heavy Duty Black Garbage Bag
XXXHD46	#320 46 Gallon Extra Extra Heavy Duty Black Garbage Bag
XHD58	58 Gallon Extra Heavy Duty Garbage Bag
XXHD58	#230 58 Gallon Extra Heavy Duty Black Garbage Bag
XXHD58BG	#235 58 Gallon Extra Heavy Duty Black Garbage Bag
XXHD58K	#238 58 Gallon Extra Heavy Duty Black Garbage Bag
XXXHD58	#330 58 Gallon Extra Extra Heavy Duty Black Garbage Bag
Clear 200	23x10x39 Extra Heavy Duty Clear Garbage Bag



**SUPER WIN ENTERPRISES CORP.**  
**PAPER & PLASTICS DISTRIBUTOR**

phone: (718) 381-3381 or email: [sales@superwinent.com](mailto:sales@superwinent.com)



**WIN SONE**  
Quality Products for the Millennium

Stock #	Description
WP12x2000	#122 12" x 2000' Film
WP18x2000	#182 18" x 2000' Film
WP24x2000	#242 24" x 2000' Film
AEP12x2000	12" x 2000' AEP Sealwrap Film
AEP18x2000	18" x 2000' AEP Sealwrap Film
Mea15x4000	15" x 4000' Meat Film
Mea15x5000	15" x 5000' Meat Film
Meat17x4000	17" x 4000' Meat Film
Meat17x5000	17" x 5000' Meat Film
Meat18x4000	18" x 4000' Meat Film
Meat18x5000	18" x 5000' Meat Film
Meat19x5000	19" x 5000' Meat Film
Meat20x4000	20" x 4000' Meat Film
Produce17x5000	17" x 5000' Green Produce Film



Stock#	Description
HWP18	18" /80Gauge Hand Wrap Stretch Film

**18" Hand Wrap Stretch Film**



**SUPER WIN ENTERPRISES CORP.**  
**PAPER & PLASTICS DISTRIBUTOR**

phone: (718) 381-3381 or email: sales@superwinent.com

## WIN SONE®

Quality Products for the Millennium



Stock#	Description	Packing
1/4 52	1/4 BBL 52lb. Kraft Sack Paper Bag	250
1/4 60	1/4 BBL 60lb. Kraft Sack Paper Bag	250
1/6 52	1/6 BBL 52lb. Kraft Sack Paper Bag	500
1/6 57	1/6 BBL 57lb. Kraft Sack Paper Bag	500
1/8 52 S	1/8 52lb. Kraft Sack Paper Bag - Short	500
1/8 52 T	1/8 52lb. Kraft Sack Paper Bag - Tall	500
1/8 57 S	1/8 57lb. Kraft Sack Paper Bag - Short	500
1/8 57 T	1/8 57lb. Kraft Sack Paper Bag - Tall	500
5x7	5 x 7 Kraft Magazine Paper Bag	8000
6x9	6 x 9 Kraft Magazine Paper Bag	6000
7x10	7 x 10 Kraft Magazine Paper Bag	4000
8x11	8 x 11 Kraft Magazine Paper Bag	4000
10x13	10 x 13 Kraft Magazine Paper Bag	2000
12x15	12 x 15 Kraft Magazine Paper Bag	2000
15x18	15 x 18 Kraft Magazine Paper Bag	1000
17x21	17 x 21 Kraft Magazine Paper Bag	1000
17x4x24	17 x 4 x 24 Kraft Magazine Paper Bag	500
PT. LIQR	Pint Liquor Bag	4000
QT. LIQR	Quart Liquor Bag	3000

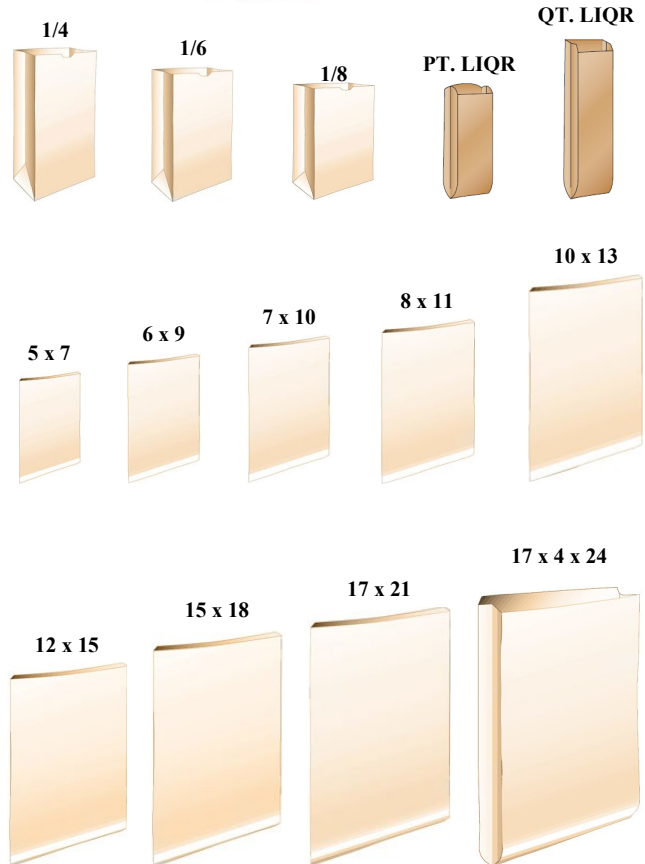

## Paper Shopping Bags White or Kraft

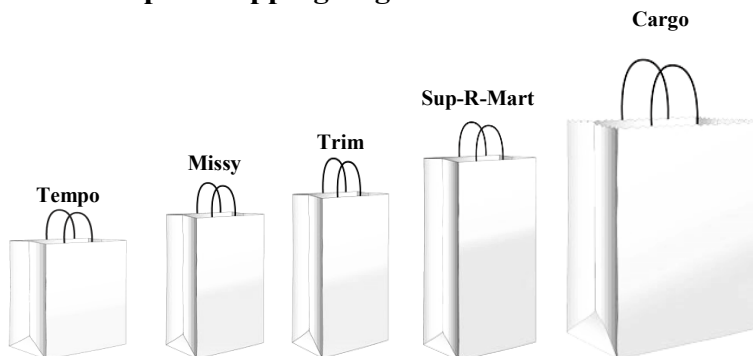

Stock #	Description	Packing
Cargo (Jumbo)	18 x 7 x 18.8 Shopping Bag	200
Sup-R-Mart (Large)	13 x 7 x 17 Paper Shopping Bag	250
Debbie/Trim (JR)	9 x 5.75 x 13.5 Paper Shopping Bag	250
Missy (Small)	10 x 5 x 13 Paper Shopping Bag	250
Tempo	8 x 4.5 x 10.25 Paper Shopping Bag	250



**SUPER WIN ENTERPRISES CORP.**  
**PAPER & PLASTICS DISTRIBUTOR**

phone: (718) 381-3381 or email: sales@superwinent.com

**WIN SONE**  
Quality Products for the Millennium

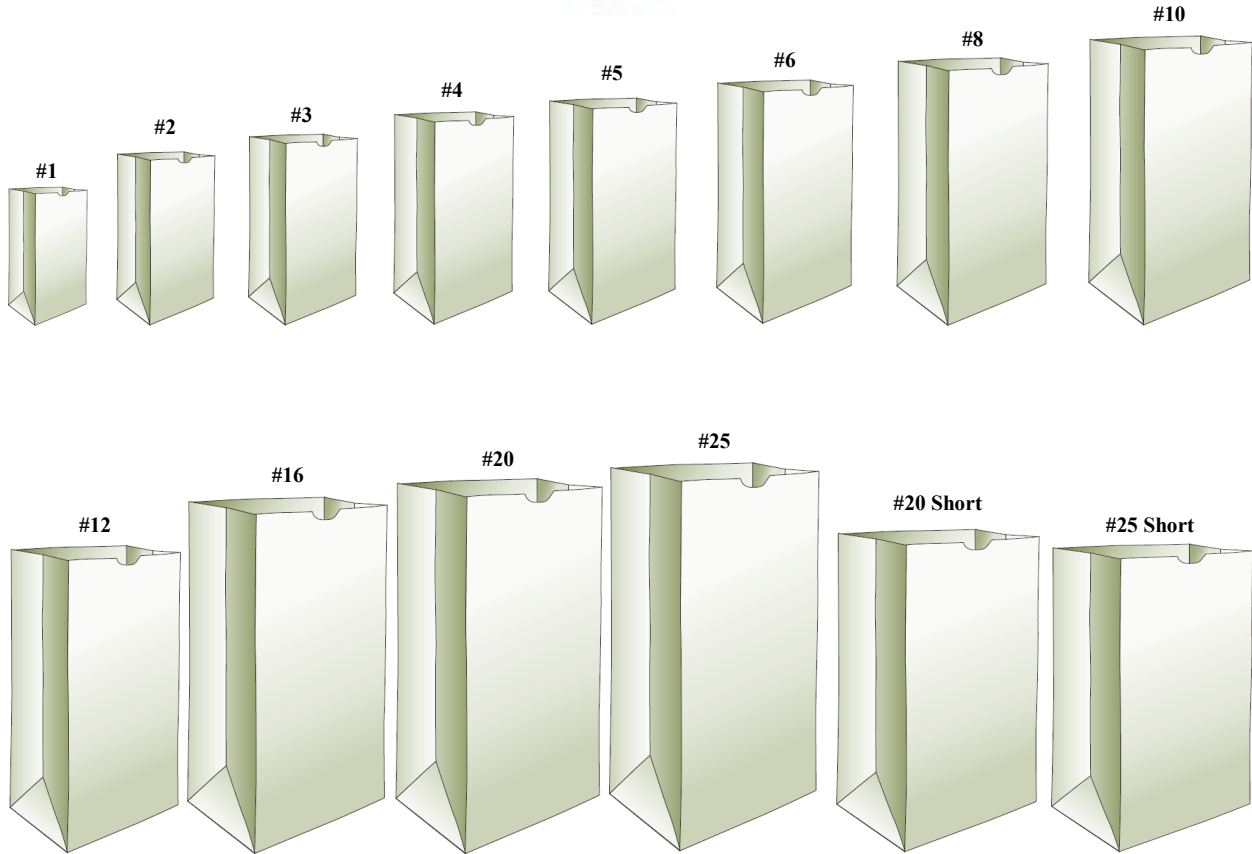

Light Kraft	Heavy Kraft	Extra Heavy Kraft	White	Dimensions
1 # LD - 8000	-	-	-	44 x 38.5 x 47.5
2 # LD - 6000	-	2 # XHD - 3000	2 # W - 6000	43 x 41.5 x 50
3 # LD - 5000	-	-	3 # W - 5000	43 x 36.5 x 48
4 # LD - 4000	-	4 # XHD - 2000	4 # W - 4000	43 x 41.5 x 46
5 # LD - 2000	-	5 # XHD - 2000	5 # W - 2000	46 x 34 x 47.5
6 # LD - 2000	-	6 # XHD - 1000	6 # W - 2000	47 x 35 x 48
8 # LD - 2000	8 # HD - 1000	8 # XHD - 1000	8 # W - 2000	44.5 x 40 x 48
10 # LD - 2000	10 # HD - 1000	10 # XHD - 1000	10 # W - 2000	44 x 41 x 44
12 # LD - 1000	12 # HD - 500	12 # XHD - 500	12 # W - 1000	43.5 x 40 x 47
16 # LD - 1000	16 # HD - 500	16 # XHD - 500	16 # W - 1000	44.5 x 42.5 x 44.5
20 # LD - 1000	20 # HD - 500	20 # XHD - 500	20 # W - 1000	50.5 x 40 x 46.5
20 # LD(S) - 1000	20 # HD(S) - 500	-	20 # W(S) - 1000	43.5 x 44.5 x 46.5
25 # LD - 1000	25 # HD - 500	25 # XHD - 500	25 # W - 1000	47.5 x 37.5 x 46.5
25 # LD(S) - 1000	25 # HD(S) - 500	-	-	47.5 x 40 x 46.5



**SUPER WIN ENTERPRISES CORP.**  
**PAPER & PLASTICS DISTRIBUTOR**

phone: (718) 381-3381 or email: [sales@superwinent.com](mailto:sales@superwinent.com)

# Foil and Glassine Bags

**WIN SONE**<sup>®</sup>  
Quality Products for the Millennium



Stock#	Description	Packing
BBQ Large	1/2 Gallon Large Foil BBQ Bag 7 x 3 x 14	500
BBQ Pint	1 Pint Foil BBQ Bag 4 x 3 x 10 1/2	1000
BBQ Quart	1 Quart Foil BBQ Bag 5 1/4 x 3 1/2 x 12	1000
Chinese Pint	Chinese 1 Pint Foil Bag 4 x 3 x 10 1/2	1000
Chinese Quart	Chinese 1 Quart Foil Bag 5 1/4 x 3 1/2 x 12	1000

Stock#	Description	Packing
1/2LB	1/2lb Glassine Bag	1000
1LB	1lb Glassine Bag	1000
2LB	2lb Glassine Bag	1000
3LB	3lb Glassine Bag	1000



**SUPER WIN ENTERPRISES CORP.**  
**PAPER & PLASTICS DISTRIBUTOR**

phone: (718) 381-3381 or email: [sales@superwinent.com](mailto:sales@superwinent.com)

# Soup Cups, Food Trays, Hot Cups

Custom Print Available



Stock#	Description	Packing
HC8	8oz Hot Cup -White/Java/Latte	1000
HC10SQ	10oz Square Hot Cup -White/Java/Latte	1000
HC12	12oz Hot Cup -White/Java/Latte	1000
HC16	16oz Hot Cup -White/Java/Latte	1000
HC20	20oz Hot Cup -White/Java/Latte	1000
DHC8/12/16/20*	Hot and Cold Cup—Custom Print	1000

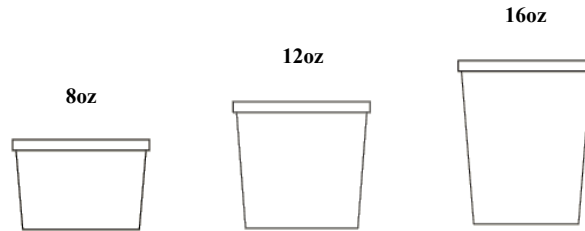

Stock#	Description	Packing
8PS-Combo	8oz White Soup Cup with Paper Lid	250
12PS-Combo	12oz White Soup Cup with Paper Lid	250
16PS-Combo	16oz White Soup Container Paper Lid	250
8PS/12PS/16PS Bottom	8oz/12oz/16oz White Soup Cup bottom	500
PS-LID	Paper Lid for Soup Cups	500
PS-PPLID	Plastic Lid for Soup Cups	1000



**SUPER WIN ENTERPRISES CORP.**  
**PAPER & PLASTICS DISTRIBUTOR**

phone: (718) 381-3381 or email: [sales@superwinent.com](mailto:sales@superwinent.com)

# Towels, Tissues, and Napkins

**WIN SONE**  
Quality Products for the Millennium



Stock #	Description	Packing
Win Sone Towel	2 ply Kitchen Paper Towel	30/70ct
Plenty	Plenty Kitchen Paper Towel	15
MCP5002	2 ply MT Royal Center Pull Sheets	6/500
MF12334K	Kraft Multifold Towels	12/334
MF12334W	White Multifold Towels	12/334
C-FOLD WHT	10" x 13" Semi-bleached	10/240
RT350	12" x 350' Kraft Roll Towel	12/350
MRT1795	12" x 350' White Roll Towel	12/350

Win Sone Towel



Plenty Towel



MF12334



MCP5002



RT350



MRT1795



Stock #	Description	Packing
WS500-124	Silkie 2 ply 400 Sheet Bathroom Tissue Individually Wrapped	12/4
SILKIE548	SILKIE Premium Quality Soft Bath Tissue individually Wrapped	12/4
05125(Tis300)	Swan 2 ply 300 Individually Wrapped Bathroom Tissue	96
05780(Tis500)	Embassy 2 ply 500 Individually Wrapped Bathroom Tissue	80
JRT-01	2 ply Jumbo Roll Tissue	12

WS500-124



SILKIE548



05125



05780



JRT-01

Stock#	Description	Packing
07401	1/4 Fold Luncheon Napkin	12/500
MP20500	Metro Hi Fold Napkin 1/6 fold -1Ply *20X500	20/500
TF10000	Wine Sone Hi-Fold Napkin 1/6 Fold 1 Ply 6"x13"	20/450
JLF20400	7" x 12' Jr. Lo-Fold	20/400
MPLFN20400	9" x 12' Lo-Fold Napkin	20/400
MP30100	Chalet 2 ply White Dinner Napkin 1/8 fold	30/100
DNAP20100	3 ply Dinner Napkin	3000
07201	White Swan 1 ply 9 x 9 Beverage Napkin	8/500



**SUPER WIN ENTERPRISES CORP.**  
**PAPER & PLASTICS DISTRIBUTOR**

phone: (718) 381-3381 or email: sales@superwinent.com

**Super Win Enterprises Corp.**  
Tel: (718) 381-3381



Stock#	Description	Packing
DP15Peach	15" Peach Steak Paper	1000'
DP15Treated	15Premium Treated Peach Paper	1000'



Stock#	Description	Packing
NP6Logan	6" x 10 3/4" Logan Wrap (Midget)	12/500
NP8Logan	8" x 10 3/4" Logan Wrap (Junior)	12/500
NP10Logan	10" x 10 3/4" Logan Wrap (Senior)	12/500
NP12Logan	12" x 10 3/4" Logan Wrap (Master)	12/500
NP15Logan	15" x 10 3/4" Logan Wrap (Jumbo)	12/500
Plain Patty Paper	4 3/4" x 4 3/4" Patty Paper	24/1000
FWW6	6" x 10 3/4" Wax Wrap Tissue (Midget)	10pk/1000ct
FWW8	8" x 10 3/4" Wax Wrap Tissue (Junior)	10pk/1000ct
FWW10	10" x 10 3/4" Wax Wrap Tissue (Senior)	8pk/1000ct

**WIN SONE**<sup>®</sup>  
Quality Products for the Millennium



Dry Wax Wrap (Bakery Tissue)



**WIN SONE**<sup>®</sup>  
Quality Products for the Millennium

Stock#	Description	Packing
6/1000	6" Paper Plate	1000
WS-9/500	9" Coated Heavy Duty Paper Plate	2x200
9 in paper plate	9" White Paper Plate Uncoated	10 x100
HP9S-2050	SOLO 9" White Heavy Weight Paper Plate	4 x 125
HP9S-J8001	SOLO 9" Symphony Heavy Weight Paper Plate	4 x 125



**SUPER WIN ENTERPRISES CORP.**  
**PAPER & PLASTICS DISTRIBUTOR**

phone: (718) 381-3381 or email: [sales@superwinent.com](mailto:sales@superwinent.com)



**Super Win Enterprises Corp.**  
Tel: (718) 381-3381



Atlas Paper	Delta Paper	Description	Packing
AP8x30	DP8x30	8" x 30" Peach Steak Paper	1000
AP10x30	DP10x30	10" x 30" Peach Steak Paper	1000
AP12x24	DP12x24	12" x 24" Peach Steak Paper	1000
AP12x26	DP12x26	12" x 26" Peach Steak Paper	1000
AP12x30	DP12x30	12" x 30" Peach Steak Paper	1000



### Freezer Paper



### Dry Wax Meat Wrap



### MG Roll



### Premium MG Roll



Atlas Paper	Norpak	Win Sone	Description	Packing
AP9x12DryWax	NP912DW	-	9" x 12" Dry Wax Sheet	1000
AP9x12WetWax	-	-	9" x 12" Wet Wax Sheet	1000
AP12x15DryWax	NP1215DW	WS1215DW	12" x 15" Dry Wax Sheet	1000
AP12x15WetWax	NP1215WW	WS1215WW	12" x 15" Wet Wax Sheet	1000
AP14x18DryWax	-	WS1418	14" x 18" Dry Wax Sheet	1000
-	NP15DeliWrap	WS15WW	15" Wet Wax Paper	1000'
-	NP15DW	-	15" Dry Wax Paper	1000'
-	WS15MG-NP	WS15MG30	15" MG Roll	1000'
-	NP15MG35	-	15" MG Premium Counter Roll	1000'
-	-	WS15MG40	15" Premium Butcher Roll	1000'
-	NP15MW	-	15" Meat Wrap Counter Roll	1000'
-	NP15Precoat	-	15" Pre-coat Counter Roll	1000'
-	NP15FreezerRoll	-	15" Freezer Roll	1000'
-	NP18MeatWrap	-	18" Meat Wrap Butcher Roll	1000'
-	NP18Rensie	-	18" Rensie Roll	1000'
-	NP24MeatWrap	-	24" Meat Wrap Butcher Roll	1000'
-	NP18MG	-	18" MG Premium Counter Roll	1000'
AP-Quilon Pan Liner	Bakery Pan Liner	-	16 3/8" x 24 3/8" Pan Liner	1000'

### Wet Wax paper

### Dry Wax Sub Wrap

### Pan Liner

### Dry Wax Paper



**SUPER WIN ENTERPRISES CORP.**  
**PAPER & PLASTICS DISTRIBUTOR**

phone: (718) 381-3381 or email: [sales@superwinent.com](mailto:sales@superwinent.com)

**WIN SONE**<sup>®</sup>  
Quality Products for the Millennium

Available  
PFAS Free



Stock #	Description	Packing
WS-BP10	Bagasse 10 inch Round Plate 400 (2x200)	2 x 200
WS-BP103C	Bagasse 10 inch 3Comp Round Plate 400 (2x200)	2 x 200
WS-BP6	Bagasse 6 inch Round Plate 1000 (4x250)	4 x 250
WS-BP7	Bagasse 7 inch Round Plate 1000 (4x250)	4 x 250
WS-BP9	Bagasse 9 inch Round Plate 400 (2x200)	4 x 250
WS-BP93C	Bagasse 9 inch 3 Comp Round Plate 400 (2x200)	2 x 200



Stock #	Description	Packing
WS-B6HB	Bagasse 6x6x3 Hamburger Box (400)	2 x 200
WS-B83C	Bagasse 8x8x3 Deep 3-Comp (150)	2 x 75
WS-B8D	Bagasse 8x8x3 Deep (150)	2 x 75
WS-B9206	Bagasse 9x6x2.9 Clamshell (150)	2 x 75
WS-B93C	Bagasse 9x9 inch 3-Comp Round Plate (150)	2 x 75
WS-B9D	Bagasse 9x9 inch (150)	2 x 75
WS-BBWL12	Bagasse 12oz Bowl (1000)	4 x 250
WS-BBWL32	Bagasse 32oz Bowl (1000)	4 x 250
WS-BBWL32DL	Dome Lid for Bagasse 32oz Bowl (1000)	4 x 250



**SUPER WIN ENTERPRISES CORP.**  
**PAPER & PLASTICS DISTRIBUTOR**

phone: (718) 381-3381 or email: [sales@superwinent.com](mailto:sales@superwinent.com)

**Super Win Enterprises Corp.**  
Tel: (718) 381-3381

**WIN SONE**<sup>®</sup>  
Quality Products for the Millennium



Stock #	Description	Height Dimensions	Bottom Dimensions	Top Dimensions	Packing
#1 Box	26 oz Paper Kraft Container	2-1/2	4-3/8 x 3 -1/2	5 x 4-1/2	9 x 50
#2 Box	49 oz Paper Kraft Container	1-7/8	7-3/4 x 5-1/2	8-7/16 x 6-3/16	4 x 50
#3 Box	66 oz Paper Kraft Container	2-1/2	7-3/4 x 5-1/2	8-1/2 x 6-1/4	4 x 50
#4 Box	96 oz Paper Kraft Container	3-1/2	7-3/4 x 5-1/2	8-3/4 x 6-1/2	4 x 40
#8 Box	45 oz Paper Kraft Container	2-1/2	6 x 4-3/4	6-3/4 x 5-7/16	6 x 50



Stock#	Description	Packing
M51-0032	4-cup Beverage Carrier	300

M51-0032

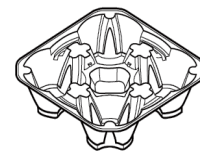

**SUPER WIN ENTERPRISES CORP.**  
**PAPER & PLASTICS DISTRIBUTOR**

phone: (718) 381-3381 or email: [sales@superwinent.com](mailto:sales@superwinent.com)

**Super Win Enterprises Corp.**  
Tel: (718) 381-3381



Stock #	Description	Packing
TDPP-40W	4" x 7" White Absorbent Food Pads	2000
TDPP-40Y	4" x 7" Yellow Absorbent Food Pads	2000
TDPP-50BLK	5" x 7" Black Absorbent Food Pads	2000
TDPP-50R	5" x 7" Rose Absorbent Food Pads	2000
TDPP-50W	5" x 7" White Absorbent Food Pads	2000
TDPP-50Y	5" x 7" Yellow Absorbent Food Pads	2000
TD-30250	30" x 250' White Case Liner	1 roll



**SUPER WIN ENTERPRISES CORP.**  
**PAPER & PLASTICS DISTRIBUTOR**

phone: (718) 381-3381 or email: [sales@superwinent.com](mailto:sales@superwinent.com)

**Super Win Enterprises Corp.**  
Tel: (718) 381-3381

**amhil**  
**north america**  
best value company

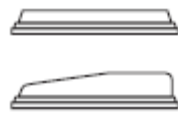

Tear-Back Lid

Dome Lid

**WIN SONE**<sup>®</sup>  
Quality Products for the Millennium

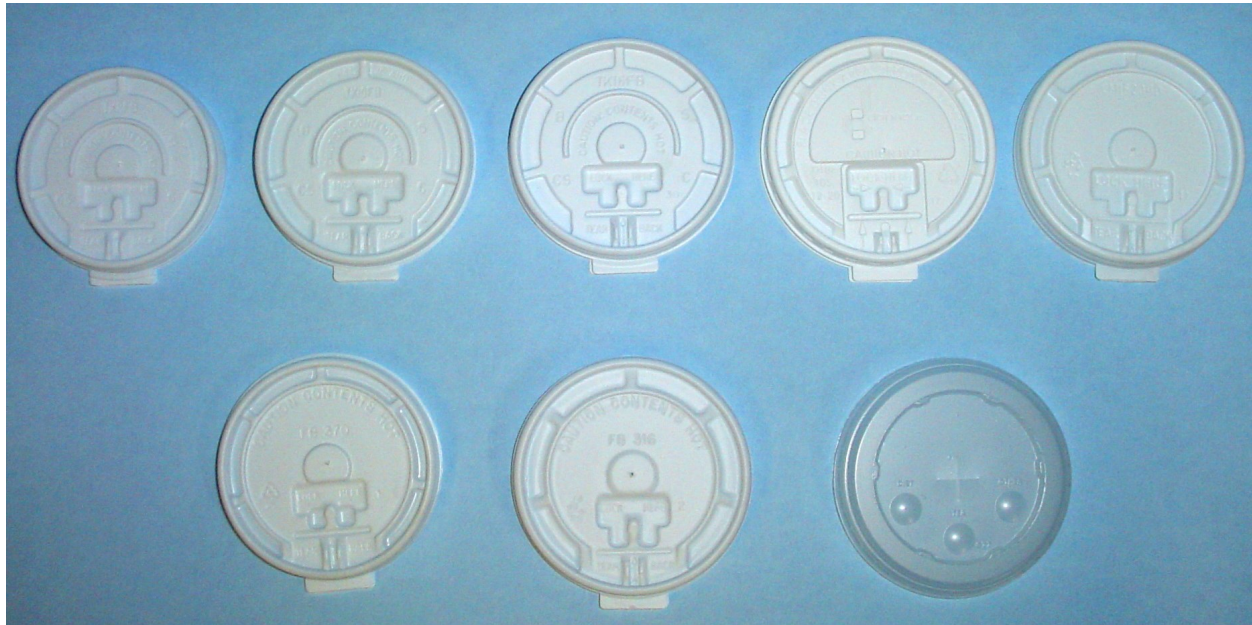

Stock #	Description	Packing
TK8FB	8oz White Vented Fold Back Lid	1000
LM1620FB	10oz to 16oz White Fold Back Lid	1000
LMD-1262H	10oz to 16oz Dome Lid White	1000
L316FB	SOLO 16oz Vented Fold Back Lid	1000
L370FB	SOLO 10oz White Fold Back Lid	1000
LB3081	SOLO 8oz Black Fold Back Lid	1000
LB3161	SOLO 10oz to 24oz Black Fold Back Lid	1000



**SUPER WIN ENTERPRISES CORP.**  
**PAPER & PLASTICS DISTRIBUTOR**

phone: (718) 381-3381 or email: [sales@superwinent.com](mailto:sales@superwinent.com)

Stock#	Description	Packing
WS0104	Green Duplicate Check Book	50
WS0105	Pink Duplicate Check Book	50
WS0240	Single Page Check Book	50
WS0104 - C	Green Carbonless Duplicate Guest Check	50
WS0105 - C	Pink Carbonless Duplicate Guest Check	50
WS110-3pt	Triplicate Interleaving Carbonless Guest Check	50
Ball Pen	Blue/Black/Red Ball-point Pen	12/12
Continuous Invoice Paper	2-ply and 3-ply Invoice Paper	500

**WIN SONE**<sup>®</sup>  
Quality Products for the Millennium

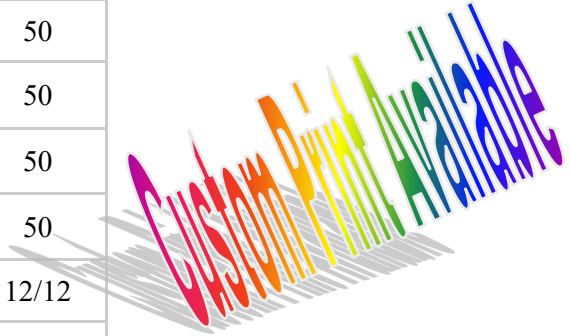

**Guest Check**

**Ball Pen**

**Invoice Paper**



Stock#	Description	Packing
38L150	38mm x 150' 1ply Cash Register Paper Roll	100
44L150	44mm x 150' 1ply Cash Register Paper Roll	100
57L150	57mm x 150' 1ply Cash Register Paper Roll	100
57L80	57mm x 80' 2ply Cash Register Paper Roll	50
T44L150	44mm x 150' Thermal Cash Register Paper Roll	50
T57L80	57mm x 80' Thermal Cash Register Paper Roll	50
T57L230	57mm x 230' Thermal Cash Register Paper Roll	50
76L150	76mm x 150' 1ply Cash Register Paper Roll	50
T80L230	80mm x 230' Thermal Cash Register Paper Roll	50
C80L90	80mm x 90' Carbonless Cash Register Paper Roll	50

**Register Paper Rolls**



**SUPER WIN ENTERPRISES CORP.**  
**PAPER & PLASTICS DISTRIBUTOR**

phone: (718) 381-3381 or email: [sales@superwinent.com](mailto:sales@superwinent.com)

**WIN SONE**®

Quality Products for the Millennium

**Mop Stick**

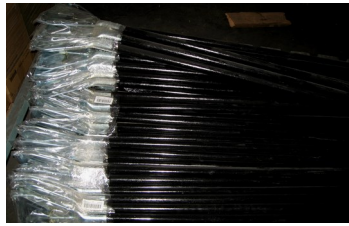

**Mop Head**



**Angle Broom**



Stock#	Description	Packing
MopHead24	24oz. Wet Cotton Mop Head	12
MopHead32	32oz Wet Cotton Mop Head	12
Mopstick	54" Center Bolt Handle	6
Angle Broom	Large Angle Broom	12

**1 Gallon Cleaning**



Stock#	Description	Packing
Bleach	Bleach 3% Sodium hypochlorite	6x 1 gallon
Cherry Deodorant	Cherry Deodorant	4x 1 gallon
Glass Cleaner	Glass Cleaner	4x 1 gallon
Grill Oven Cleaner	Oven Grill and Pan Cleaner	4x 1 gallon
Liquid Detergent	Green Liquid Detergent for Pots and Pans	4x 1 gallon
Liquid Hand Soap	Pink Liquid Hand Soap	4x 1 gallon
Pine Oil Cleaner	Pine Oil Cleaner Deodorant	4x 1 gallon
Degreaser	All Purpose Degreaser	4x 1 gallon
Lotion Hand Soap	Lotion Pink hand Soap	4x 1 gallon



**SUPER WIN ENTERPRISES CORP.**  
**PAPER & PLASTICS DISTRIBUTOR**

phone: (718) 381-3381 or email: [sales@superwinent.com](mailto:sales@superwinent.com)

# Gloves / Sanitizer / Masks Supplies

Cotton Glove



Vinyl Glove



Nitrile Glove

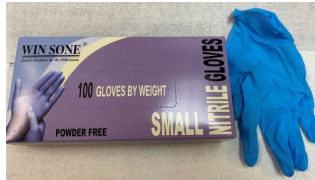

Latex Glove



Poly Glove



**WIN SONE**  
Quality Products for the Millennium

Stock#	Description	Packing
Cotton Glove	Coated Cotton Glove	30/10
Vinyl Glove S/M/L/XL	Powder Free Vinyl Glove	10/100
Vinyl Glove S/M/L/XL	Powdered Vinyl Glove	10/100
Poly Glove	Poly Glove	10/500
Latex Glove S/M/L/XL	Powdered Free Latex Glove	10/100
Latex Glove S/M/L/XL	Powdered Latex Glove	10/100
Nitrile Glove S/M/L/XL	Nitrile Glove	10/100



Stock#	Description	Packing
Face Mask	Disposable Face Mask—3 ply	50
KN-95	KN-95 Disposable Face Mask—5 ply	1



Stock#	Description	Packing
Sanitizer	Clear Liquid Hand Sanitizer - 4 Gallon/Case 70% ethyl alcohol content with added moisturizer. (1 pump included)	4x1



**SUPER WIN ENTERPRISES CORP.**  
**PAPER & PLASTICS DISTRIBUTOR**

phone: (718) 381-3381 or email: [sales@superwinent.com](mailto:sales@superwinent.com)





Available in box or bag packaging



Stock#	Description	Packing
RB10	#10 Green/Red/Natural Rubber Band	25
RB12	#12 Green/Red/Natural Rubber Band	25
RB14	#14 Green/Red/Natural Rubber Band	25
RB16	#16 Green/Red/Natural Rubber Band	25
RB18	#18 Green/Red/Natural Rubber Band	25
RB19	#19 Green/Red/Natural Rubber Band	25
RB31	#31 Green/Red/Natural Rubber Band	25
RB32	#32 Green/Red/Natural Rubber Band	25
RB62	#62 Green/Red/Natural Rubber Band	25
RB64	#64 Green/Red/Natural Rubber Band	25

**WIN SONE**  
Quality Products for the Millennium

Light Apron



Heavy Apron



Stock #	Description	Packing
Light Apron	24" x 42" Light Duty Poly Apron	10/100
Heavy Apron (WS2002)	28" x 46" Heavy Duty Poly Apron	10/25
Tying Twine	Tying Twine	1
2CT110	2" x 110 yard Clear Tape	36
Clear Tape	2" x 55 yard Clear Tape	36
RC100-Red/Blue	Cellucap Chef Cap	10/100
Fancy Heat	Methanol Gel Heating Units	72 x 200mg

Tying Twine



Fancy Heat



Clear Tape

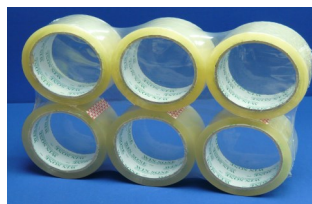

RC100



**SUPER WIN ENTERPRISES CORP.**  
**PAPER & PLASTICS DISTRIBUTOR**

phone: (718) 381-3381 or email: [sales@superwinent.com](mailto:sales@superwinent.com)



**SUPER WIN ENTERPRISES CORP.**

**1819 Flushing Avenue  
Ridgewood, NY 11385**

**51 Executive Avenue  
Edison, NJ 08817  
Tel: (718) 381-3381 Fax: (718) 381-7577**

**www.superwinent.com**

